

Balmoral Inline Lever

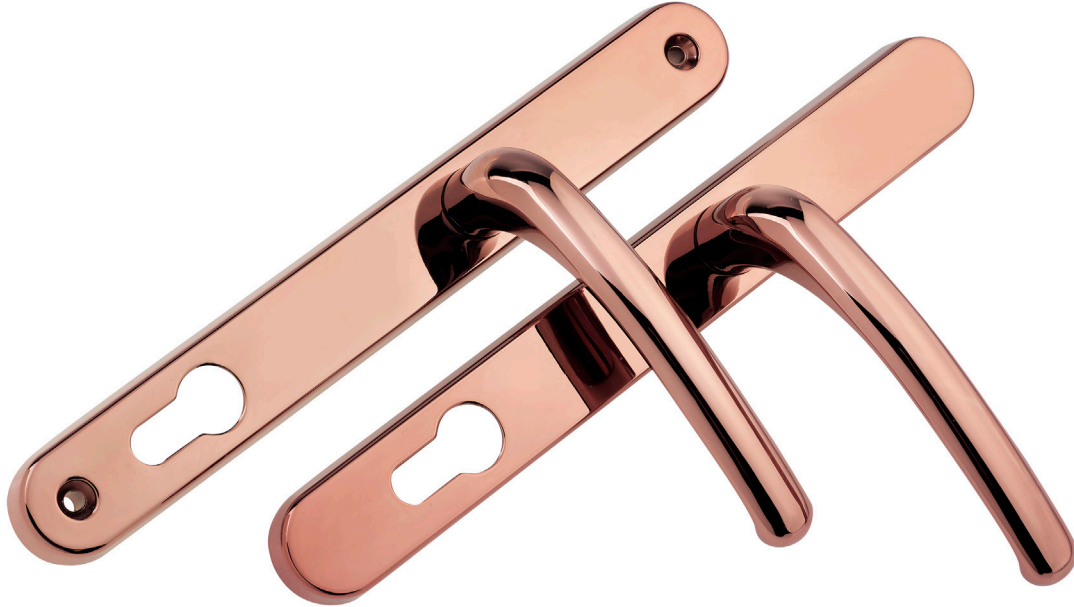

Feature:

- **Solid die cast**
Sturdy feel and consistent 90 degree lever return
- **Sculpted ergonomic lever and low friction nylon bush**
Easy to grip and smooth action
- **Supplied with screw and spindle pack to suit 60-70mm profiles**
Everything needed for installation included
- **Colour coordinated screw heads**
Perfectly matching hardware, even down to the smallest details
- **Baseplate in common with all Balmoral handles**
Same routing detail regardless of product variant chosen
- **Wide backplate**
To suit cylinder guards and accommodate larger cylinder preparation
- **Supplied with care instructions**
Helps the homeowner to keep the hardware in optimal condition
- **Supplied fully assembled**
Simple and quick installation, no need to fit springs or lever
- **Each part packaged in a separate chamber, but supplied as a set**
No scratching of parts during transit

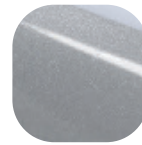

Silver



Black



White

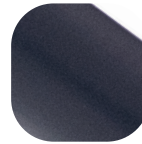

Anthracite Grey



Hardex Chrome



Hardex Satin



Hardex Bronze

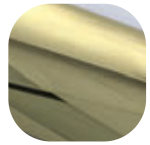

Hardex Gold

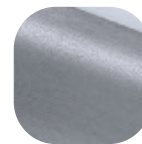

Hardex Graphite



Hardex Rose

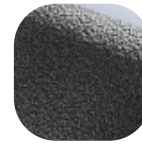

Antique Black



Hardex Pewter

Balmoral Inline Lever Lever

Ordering Details

Product

Balmoral Inline Lever Lever

Finish	Part No.
Hardex Chrome	1D001
Hardex Satin	1D002
Hardex Bronze	1D003
Hardex Gold	1D005
Hardex Graphite	1D008
Hardex Pewter	1D009
Hardex Rose	DHABLRIL
Antique Black	1D006
Anthracite Grey	1A004
White	1A000
Black	1A001
Silver	1A002

For additional part numbers please contact our sales office.

Technical Information

Corrosion resistance

Meets the requirements of BS EN 1670:2007 Grade 5 (480 hours)

Operation

Endurance tested in excess of 200,000 cycles

Performance

Tested to meet the requirements of PAS 24 as part of a compliant door set.
30 minute fire test to BS 476: Part 20/22: 1987

Material Specification

Handle Grip and Backplate:	High quality Zinc for all Hardex finishes and Antique Black. High quality Aluminium for White, Black, Anthracite Grey and Silver finishes
Coatings:	Hardex Chrome, Hardex Satin, Hardex Bronze, Hardex Gold, Hardex Graphite, Hardex Pewter, Hardex Rose, Anthracite Grey, Antique Black, White, Black and Silver
Spindle / Screws:	Machine screws with colour coordinated heads for handle. 60mm - 70mm profiles (1 x 8mm x 120mm spindle; 2 x M5 x 70mm and 2x M5 x 80mm screws)
Cylinder:	Euro Cylinder, 92mm PZ

Maintenance

For continued protection of the quality finish and appearance, Fab&Fix advise routine cleaning of all our external hardware. Moving parts should also be lightly lubricated at least twice a year. This procedure is particularly essential if products are used within a 25-mile radius of coastal areas or close proximity to building sites or large industrial areas, where more frequent cleaning may be required to prevent the accumulation of corrosive contaminants.

Packaging

Handles

Individually bagged with screws, spindle and care instructions.
15 handles in an outer box.

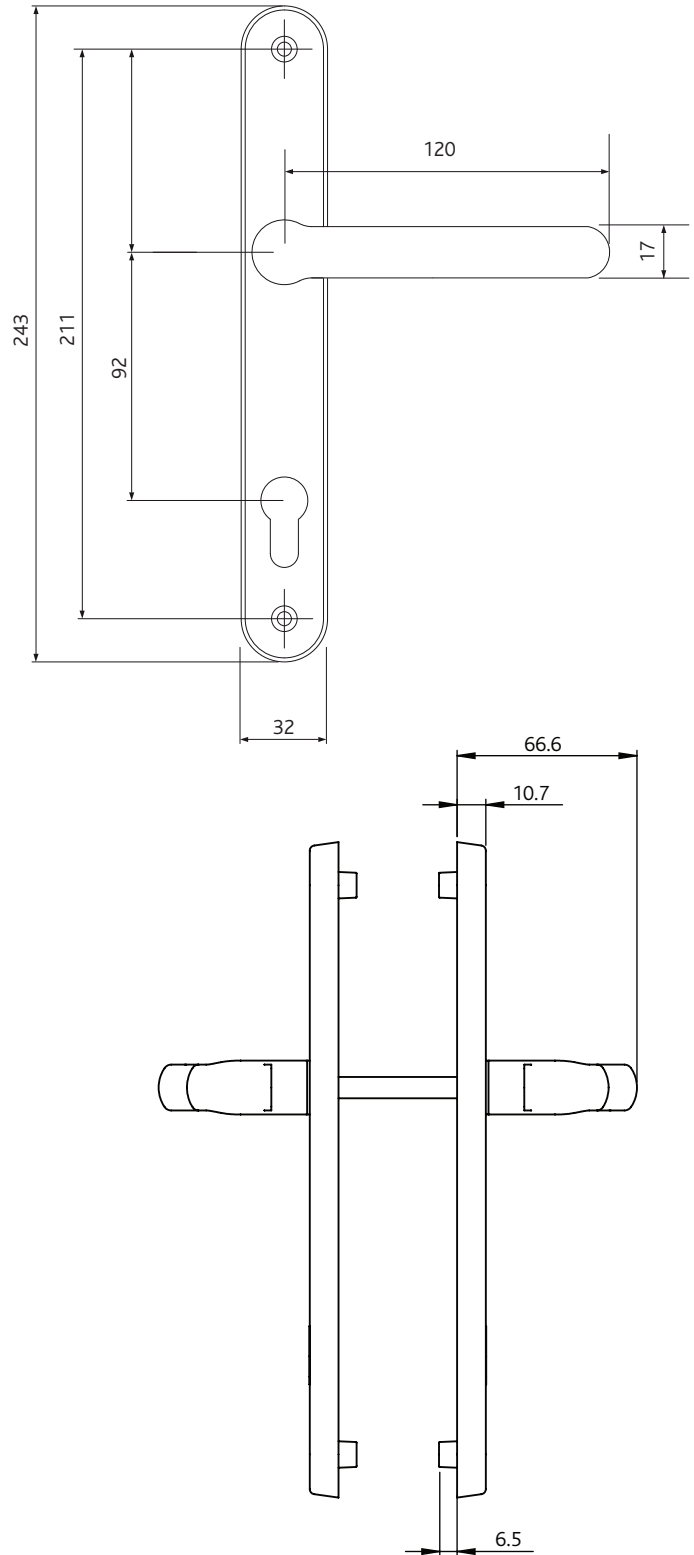

All dimensions are in mm and are nominal.
Fab&Fix reserves the right to change specification without notice.
It is the responsibility of the door manufacturer to ensure that the finished product meets any required safety and performance specification.